

**All questions worth 4 points.**

1. Lucy knows that some liquids do not mix (see the picture) and she poured glycerin, alcohol, oil and water in a vessel. Starting from the bottom, what's the order of the liquids?



- A) Water, glycerin, oil, alcohol  
B) Glycerin, water, oil, alcohol  
C) Oil, glycerin, alcohol, water  
D) Oil, glycerin, water, alcohol  
E) A uniform mixture
2. Woodpecker is an arboreal bird, which consumes harmful insects. Indicate its characteristics:



- A) Sharp beak and toes joined at the base by an interdigital membrane  
B) Bent beak and crooked sharp toes  
C) Strong beak and four toes, two backward oriented and two forward oriented  
D) Widened beak and toes joined by an interdigital membrane  
E) Widened beak and four toes, two backward oriented and two forward oriented
3. John has an iron object which he introduces in a water vessel. He notices that the object floats inside the liquid. What does John conclude?
- A)  $\rho_{Fe} = \rho_{water}$   
B)  $\rho_{Fe} < \rho_{water}$   
C) The situation is impossible  
D) The iron object has interior hollows  
E) The temperature of the object is lower than the one of the water

4. The apple tree and the fir tree are superior woody plants. They both share the following features:



- A) They have roots, deeply embedded in the ground
  - B) They have fruits whose function is to spread seeds
  - C) They have flowers that attract insects for pollination
  - D) They have leaves that perform photosynthesis
  - E) They have seeds which are spread by the wind
5. After using the umbrella on a rainy day, we can take away water from it by shaking it. What physical property makes this possible:



- A) Divisibility
- B) Inertia
- C) Solid objects have volume
- D) Objects can interact
- E) Water evaporates

6. We are riding a bus and we want to use our magnetic compass. Can we?



- A) Yes, the pointer will always orient itself on the direction North-South
- B) No, the orientation of the pointer is perturbed by the moving bus
- C) No, because the bus shell will block the magnetic field
- D) Only if the bus is moving on the direction North-South
- E) Only if it is not raining



7. Mary placed 30 sprouted seeds in a jar, whose top is covered. Initially, the seeds weight was 45g. After 3 days, the weight was 39g. Explain the result:
- A) The water was evaporated into the environment through perspiration
  - B) The organic substances from seeds were consumed in respiration
  - C) The plant produced organic substances through photosynthesis
  - D) The seeds were waterlogged
  - E) The seeds absorbed the mineral substances
8. Four masses are in thermal equilibrium at a temperature  $t_0$ . By removing one, the temperature of the others:
- A) Increases, no matter what the removed mass is
  - B) Stays the same
  - C) Becomes a half
  - D) Doubles
  - E) Increases only if the removed mass is bigger than the mass left
9. Establish the correct connection between the plants' organs and their uses:

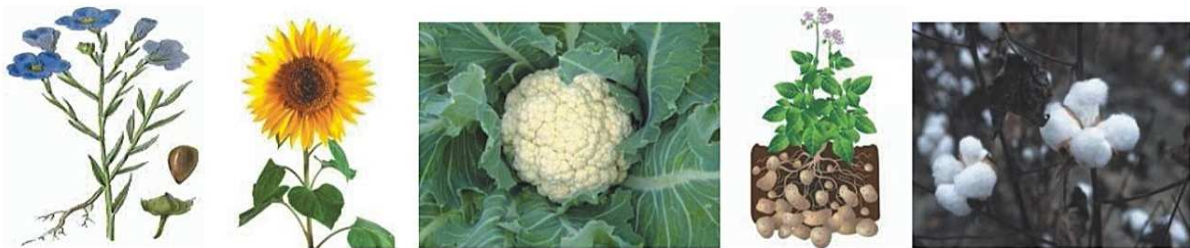

- A) Flax stems → clothing products
  - B) Sunflower stems → animal forage
  - C) Cauliflower leaves → human nutrition
  - D) Potato fruits → human nutrition
  - E) Cotton stems → clothing products
10. Optically, the fog is:
- A) Translucent
  - B) A perfect reflector
  - C) Totally opaque
  - D) Diffuse
  - E) Transparent

11. The tongue of some animals is attached to the front of the mouth whereas the human tongue is attached in the back of the mouth. Which of the following animals have a tongue attached to the front of their mouth?



- A) The catfish  
 B) The lake frog  
 C) The turtle  
 D) The rattlesnake  
 E) The Nile crocodile

12. Two flat mirrors,  $O_1$  and  $O_2$  form an angle  $\alpha$ ,  $\alpha < 90^\circ$ . A light ray hits the first mirror at an incident angle  $i$ . After reflecting on both mirrors, the angle between the reflected and the incident rays is:

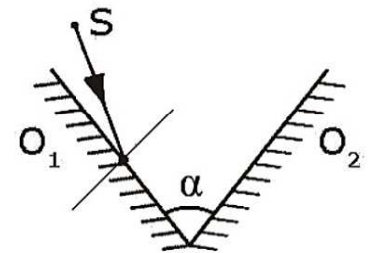

- A)  $2\alpha$   
 B)  $\alpha + i$   
 C)  $2i$   
 D)  $2(\alpha + i)$   
 E)  $90^\circ$

13. Ana cultivated several plants in the garden: 30 onion plants, 20 pepper plants and 40 plants of sweet potatoes. Indicate from how many of them Ana will consume the fruits.



- A) 90 plants  
 B) 50 plants  
 C) 70 plants  
 D) 20 plants  
 E) 40 plants

14. The trajectory of point on a bike's wheel, running at a certain velocity is:

- A) A point  
 B) A circle  
 C) A line  
 D) An ellipse  
 E) Depends on the reference system



15. Lavandula is a genus of flowering plants which are cultivated in gardens worldwide and are famous for the aromatic substances they produce. Select the correct statement about this plant tissues and their role:



- A) Collenchyma → produces nutrients
  - B) Dermal tissue → ensures the resistance of the plant
  - C) Parenchyma → produces aromatic substances
  - D) Xylem → supplies nutrients
  - E) Sclerenchyma → protects the plant
16. A bottle is sealed with a glass stopper which is stuck in its neck. How can we open it?



- A) Cooling the bottle's neck
  - B) Heating the glass stopper
  - C) Heating the glass stopper and the bottle
  - D) Electrifying the bottle's neck
  - E) Heating the bottle's neck
17. Growth rings, also referred to as tree rings or annual rings, can be seen in a horizontal cross section cut through the trunk of a tree from temperate or cold regions. By counting them, we can tell how old a tree is. These growth rings are determined by the following tissue:



- A) Meristematic tissues
- B) Parenchyma
- C) Secretory tissue
- D) Dermal tissue
- E) Vascular tissue

18. The circuit below is connected to a power supply. The 3 bulbs  $B_1$ ,  $B_2$  and  $B_3$  are identical. By closing the switch  $K$ , the light from  $B_1$  will be (compared to the case when the switch is open):

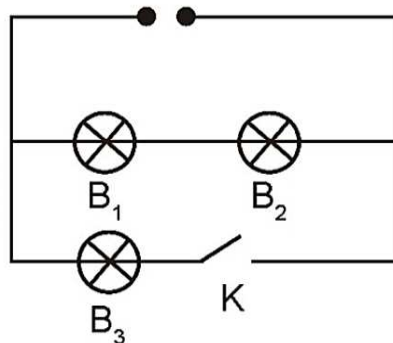

- A) Two times dimmer
  - B) Three times dimmer
  - C) The same
  - D) Two times brighter
  - E) Three times brighter
19. Lichens are distinguished from moss by the following features:

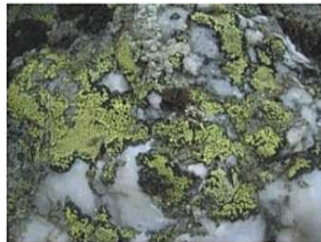

- A) Reduced size
  - B) The way of feeding
  - C) The way they form the first layer of soil
  - D) High resistance to dryness
  - E) Terrestrial life environment
20. For the circuit in the figure, in order to reverse the indication of the ampermetre, we have to:

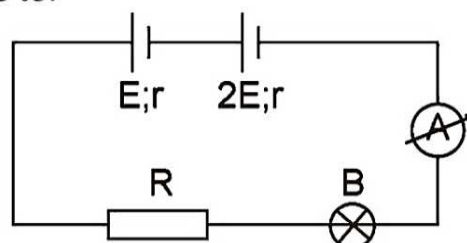

- A) Remove the bulb  $B$
- B) Reverse the polarity of the battery with the e.m.f  $2E$
- C) Reverse the polarity of the battery with the e.m.f  $E$
- D) Connect the batteries in parallel without modifying the initial polarity
- E) Connect the bulb  $B$  and the resistor  $R$  in parallel

21. Select the correct route followed by an oxygen molecule from the lungs of a rabbit to its organs:

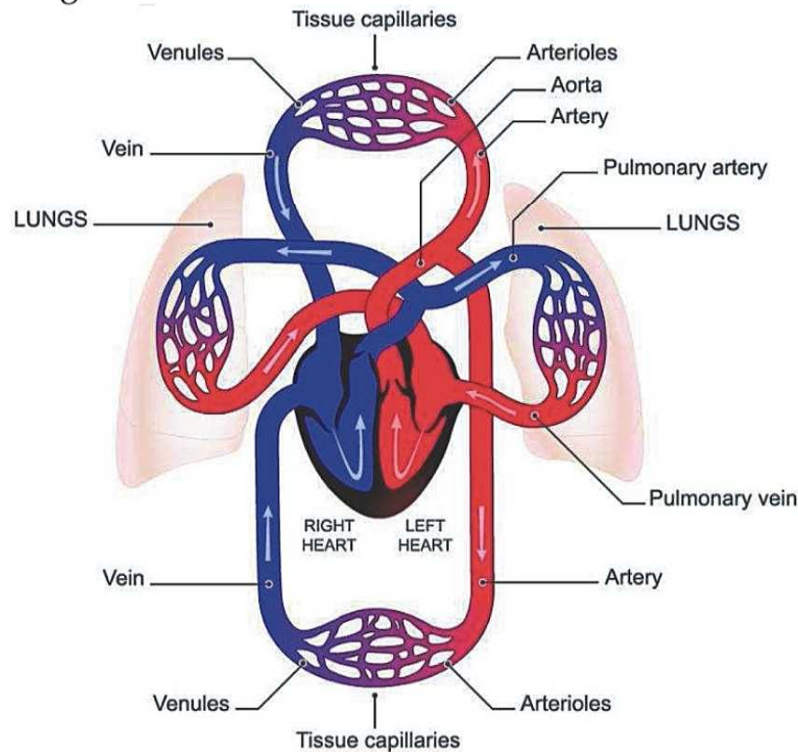

- A) lungs - pulmonary vein - left atrium - left ventricle - aorta  
 B) lungs - pulmonary artery - the left atrium - left ventricle - aorta  
 C) lungs - pulmonary artery - right atrium - right ventricle - aorta  
 D) lungs - pulmonary artery - the left atrium - left ventricle - aorta  
 E) lungs - aorta - left atrium - left ventricle - pulmonary artery
22. What is the density of an alloy composed of two metals having the densities  $\rho_1$  and  $\rho_2$  if the masses of the 2 metals satisfy the following condition  $m_1 = km_2$ .

A)  $\frac{\rho_1 + \rho_2}{2}$

B)  $\frac{k\rho_1\rho_2}{\rho_1 + \rho_2}$

C)  $\frac{k\rho_1 + \rho_2}{2k}$

D)  $\sqrt{k\rho_1\rho_2}$

E)  $\frac{(1+k)\rho_1\rho_2}{\rho_1 + k\rho_2}$



23. Blood is composed of plasma and cells. Difficulties in transportation of respiratory gases, oxygen and carbon dioxide occur due to:

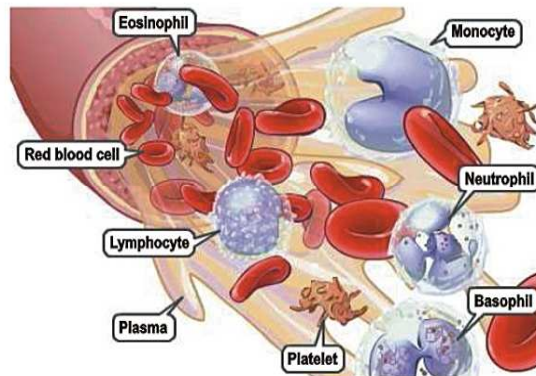

- A) The decrease of leukocytes number - white blood cells
  - B) The increase of leukocytes number - white blood cells
  - C) The reduction of erythrocytes - red blood cells
  - D) The decrease of thrombocytes number - platelets
  - E) The increase of red blood cells number
24. A boat is travelling between 2 ports on a river. The journey lasts for the time  $t_1$  downstream and  $t_2 = 2t_1$  upstream. Considering that the relative speed  $v_b$  of the boat to the water is constant, what is the speed of the water?
- A)  $v_b/3$
  - B)  $v_b/2$
  - C)  $3v_b$
  - D)  $2v_b$
  - E)  $v_b$
25. The digestive system of rabbits and dogs has the following common features:

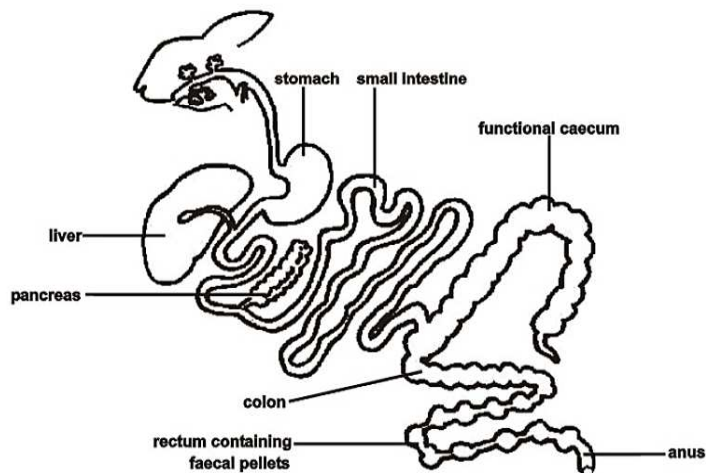

- A) the bladder stores urine
- B) the small intestine is long
- C) the incisors are well developed
- D) the gallbladder stores bile
- E) the small intestine is short



# INTERNATIONAL KANGAROO SCIENCE CONTEST 2017

Time Allowed: 60 minutes

26. A vessel weights  $m_1= 250\text{g}$  empty and  $m_2= 300\text{g}$  when it is completely filled with water. In the filled vessel a solid object of mass  $m_3= 10\text{g}$  is introduced and the total mass (the vessel, the remaining water and the solid object) is found to be  $m_4= 306\text{g}$ . Knowing the density of water, find the density of the object,  $\rho_{\text{water}} = 1 \text{ g/cm}^3$ .

A)  $7.8 \text{ g/cm}^3$

B)  $19.3 \text{ g/cm}^3$

C)  $2500 \text{ kg/m}^3$

D)  $10.5 \text{ g/cm}^3$

E)  $800 \text{ kg/m}^3$

27. The following animals have stinging cells in the body wall:

A) The medusa and the starfish

B) The red coral and the hydra

C) The octopus and the lake shell

D) The medusa and the crayfish

E) The garden snail and the octopus

28. In a glass tube of length  $1\text{m}$ , full of water, from the top a metal ball falls uniformly with a speed of  $5 \text{ cm/s}$ , relative to the water. If the ball touches the bottom after  $25\text{s}$ , what is the speed and the direction of the water in the tube?

A)  $20 \text{ cm/s}$  upwards

B)  $20 \text{ cm/s}$  downwards

C)  $9 \text{ cm/s}$  upwards

D)  $1 \text{ cm/s}$  upwards

E)  $1 \text{ cm/s}$  downwards

29. The salamander and the gray lizard have the following common features:



A) Double breathing

B) Three chambered heart

C) Constant temperature

D) Scaly skin

E) Cutaneous respiration (or cutaneous gas exchange)

# INTERNATIONAL KANGAROO SCIENCE CONTEST 2017

Time Allowed: 60 minutes

---

30. An aluminum object ( $\rho_0 = 2.7 \text{ g/cm}^3$ ) has a volume of  $1 \text{ dm}^3$  at  $0^\circ \text{C}$ . By heating it, its density becomes  $\rho = 2.696 \text{ g/cm}^3$ . How does its volume change?
- A) It stays the same
  - B) It decreases by  $1.48 \text{ dm}^3$
  - C) It increases by  $1.48 \text{ cm}^3$
  - D) We can't tell, we don't know the coefficient of volumetric expansion
  - E) We can't tell, we don't know the change in temperature

---

**Good Luck**

---